

PRODUCT SPECIFICATION

DEKO DC2200 GT

Drying Cabinet



Preventing infections since 1976.

DEKO
MEDTECH

Application

The DC2200GT Drying Cabinet provides safe and effective means to speed up processing of devices in medical and laboratory environments. Time and temperature controls along with effective HEPA filtered airflow allow fast drying of reprocessable devices. Single door and pass-through options for optimizing workflows in CSSDs.

The DC2200GT Drying Cabinet is suitable for automatic drying of medical devices intended for re-use such as;

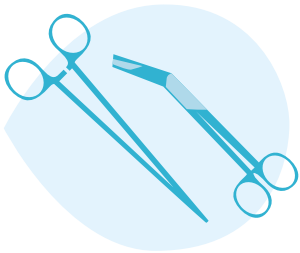

Surgical instruments and MIS instruments

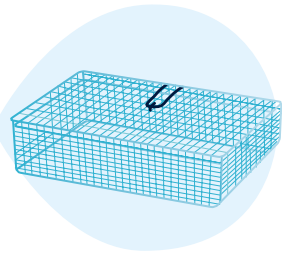

Instrument trays

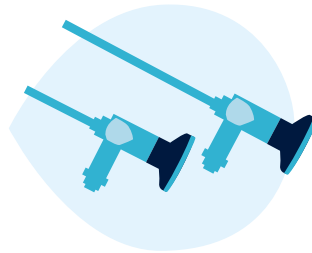

Rigid endoscopes



Anaesthetic and respiratory equipment



Hospital bowls and other plasticware



Glassware



Transit containers

Customize the drying cabinet by selecting desired features

The new DC2200 GT drying cabinet is designed with a modular structure. With adaptability and custom selection of features, the drying cabinet can be easily tailored to meet local needs and requirements.

Main features

Choose one of the options from each category.



Electricity

- 3-phase: 400–415 V, 50/60 Hz, 3x16A
- 1-phase: 230 V, 50/60Hz, 1x16A



Cabinet body

- Single door
- Double door (pass-through)



Door(s)

- Glass door(s)
- Stainless steel door(s)



Inserts

- Shelf set
- Anaesthetic set
- Hose set
- None / tailored

Optional features

Enhance the usability with one or more options.

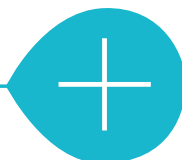

- Heat exchanger
- Additional hose guides
- Additional shelf rails
- Additional shelves



Features and functionalities

– benefits for the user

Maximized capacity

Stream-lined shape and maximized chamber dimensions with freely adjustable inserts offer a large capacity with flexibility in use.

Efficient drying and increased capacity

HEPA EU13 filtered airflow for safe drying of a wide variety of different devices. Automatic filter quality monitoring and change indication. Even 3 times greater drying efficiency compared to washer-disinfectors, DC2200 GT saves time and energy and frees washer-disinfector capacity.

Programs

Program library with 3 factory-set programs. Programs are easily adaptable to suit instrument processing requirements. Temperature range 30–80 °C, time range 1–180 minutes with optional cooling phase 1–30 minutes in the end. Internal memory provides a pre-set cycle library for creating tailored programs. User adjustable audible indicator notifying end of cycle.

Power options

3-phase / 400–415 V or 1-phase / 230V electrically heated versions.

Single door or double-door

DC2200 GT is available as a single door stand-alone model or as a double-door model for pass-through installations, optimizing workflows.

Door(s) and panels

Choose between a glass door for visual process control and capacity checks without cycle interruptions or a cost-efficient solid stainless steel door. Framework, panels and chamber all made of stainless EN 1.4301 steel and fully recyclable. All outer panels and tempered window(s) heat and sound insulated. Check the door handing guide (p.10) to determine the best door handing option for the installation site.

Heat exchanger (optional feature)

An optional heat exchanger generates optimized performance and more economical processes. Equipped with a heat exchanger, the drying efficacy is improved up to 50%, set process temperatures are reached faster and the heat distribution within the chamber is more even. Exhaust air temperature led to property exhaust air channels is even 35% lower and the drying cabinet is 30% more energy efficient. If the heat exchanger is not ordered, the cabinet is fitted with a direct air channel.

Display (loading side)

Easy-to-use touch screen display providing enhanced process control. 3.7" 5-colour touch-screen (alerts in colour). The display provides clear and informative user and service instructions. Cycle phase indication: current cycle name, sequential cycle number, remaining cycle time, current phase and chamber temperature.

Process status indication, unloading side (double door models)

Coloured led-indicators on unloading side for clear and simple visual detection of process status and remaining cycle time indication.

Independent tamper-proof process verification

Machine is equipped with a temperature indicator, independent from the controller, to allow the user to verify attainment of programmed drying temperature.

Media connections

Media connections are located on top of the machine.

- Exhaust outlet 90 mm
- Electric cable (circuit breaker supply by the buyer / installation party)

Inserts

With a range of different insert sets and accessories available, DC2200 GT can be easily adapted to varied needs.

There are three prefab, expandable insert sets to choose from or the cabinet may be tailored to specific customer needs by selecting a mix & match set of individual inserts. Selection of ready-made sets: shelf set, anaesthetic set and hose set. See p. 5 for details.

Increased adaptability

All shelves are independently removable and height adjustable. Shelves slide out for easier loading and unloading. Shelves require shelf rails. Drying cabinet can be equipped with spare rails to facilitate fast and easy height adjustment of shelves.

Accessories

Shelf rails and wire shelves (full- and partial-width) are available as accessories. Maximum capacity 13 shelves with 85 mm net clearance.

Separate hose guides for 2 x 6 hoses, placed parallel to the cabinet door on the front of the chamber roof, can be added to any ready-made insert set or chosen as a mix & match accessory. Choose between cassette for AN-hoses (> 15mm) or suction hoses (> 5mm), see pictures on p. 5.

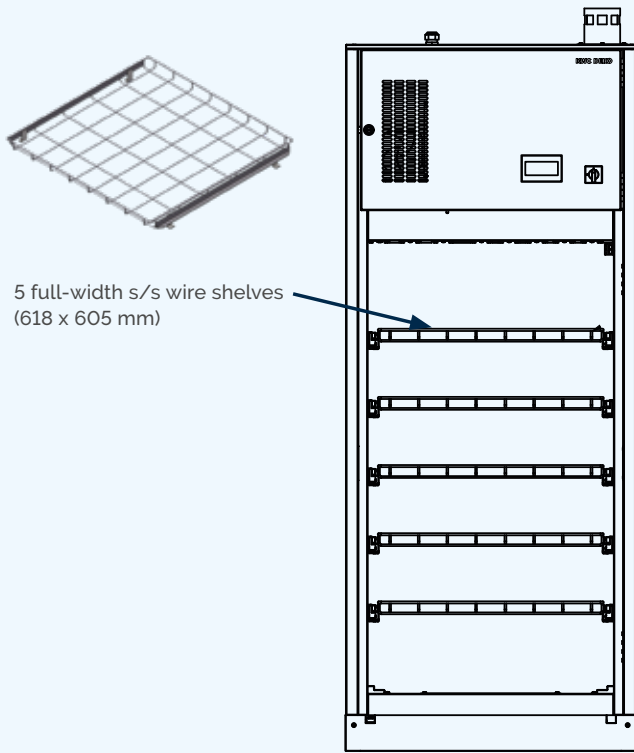

Shelf set

With 5 full-width wire shelves allowing maximum air flow, the shelf set is optimal for drying instruments, hollow-ware, glassware, containers and similar items. Min. 195 mm clearance between shelves with prefab setting.

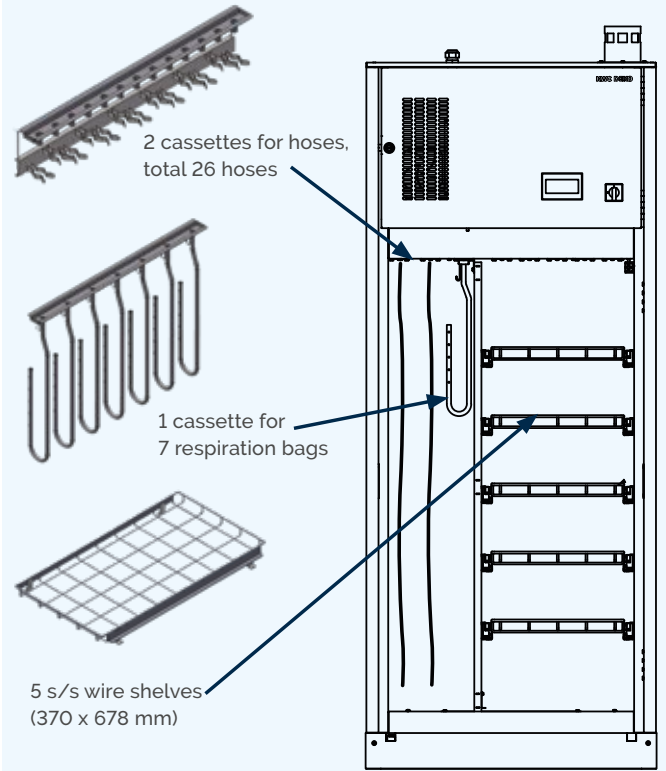

Anaesthetic set

Inserts and couplings for 7 respiration bags and 26 AN hoses + partial-width wire shelves for masks and other devices/instruments. Hose length max. 1200 mm straight hanging.

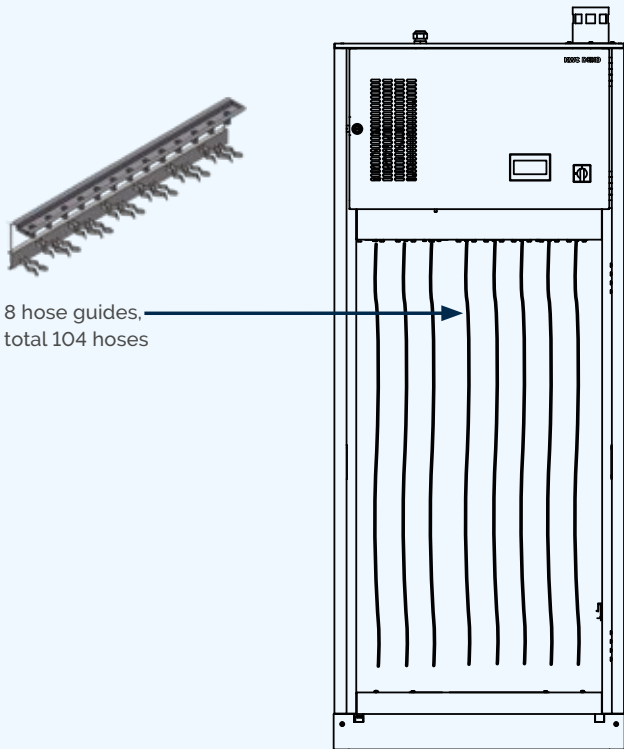

Hose set

For drying large amounts of hoses, the chamber roof can be equipped with up to 8 hose guides. With 13 hoses/guide, total capacity is 104 hoses. Hose length max. 1200 mm straight hanging.

Accessories



Cassette for 6 AN-hoses



Cassette for 6 suction hoses



Cassette for 13 hoses

Technical info

Model	DC2200 GT
Material	Stainless EN 1.4301 steel
Display	
3,7" touch-screen	X
Signal leds on unloading side (double door models)	X
Door functioning	
Manual hinged door	X
Single door model	X
Double doors / pass-through model with door interlock	X
Glass door(s), sound and heat insulated safety glass	X
Stainless steel door(s), sound and heat insulated	X
Measurements	
Width (mm)	810
Depth (mm)	770
Height (mm)	1970
Chamber volume, l (gross)	613
Chamber volume, l (effective)	452
Chamber dimensions, mm (gross)	W 686 x D 710 x H 1260
Chamber dimensions, mm (effective)	W 600 x D 610 x H 1235
Weight, kg	220
Floor loading, kN/cm ²	0.05
Adjustable feet for levelling ±10 mm	X
Media connections	
Exhaust duct	ø 90 mm
Required property ventilation (exhaust air) capacity, l/s	30
Power and electric features	
Total power, kW	3,6 / 5,7
Heating power, kW	
• 400-415V - 3 phase	4,76
• 230V - 1 phase	3,26
Drying fan, kW	0,4
Air throughput, m ³ /h	110
Total maximum heat transmission (W/m ²)	174
Maximum fascia heat transmission (W)	120
Mean sound power level (A), dB	68
Peak sound power level (A), dB	70
Electric connection *	U 400-415V 3N AC 50/60Hz 3x16A U 230V 1N AC 50/60Hz 1x16A
Controls/Programmes	
Programmability	X
Pre-set programmes	3
Customizable programme positions	6
Cycle status display	X
Cycle complete indication with mutable buzzer	X
Password protected modes	3
Load temperature protection and over temperature cut-outs	X
HEPA filter condition indication	X
Automatic maintenance reminder	X
Standard compliance	
RoHs 2011/65/EU	X
IEC 61010-1	X
IEC 61326-1	X
EN ISO 13485	X

X = Standard * = Regional options

Drying cabinet equipped with heat exchanger - a sustainable choice

	Variant	
	3-phase 400-415V	1-phase 230V
Set process temperature reached	35 % faster	50 % faster
Drying time	50 % shorter	50 % shorter
Exhaust air temperature	33 % lower	35 % lower
Energy saving / consumption	30 % less	30 % less

Compared to corresponding standard model with direct air channel.
Results based on 3hr program run with warm cabinet, actual results may vary.

Two door options



Glass door(s)



Stainless steel door(s).

Installation

Single door model

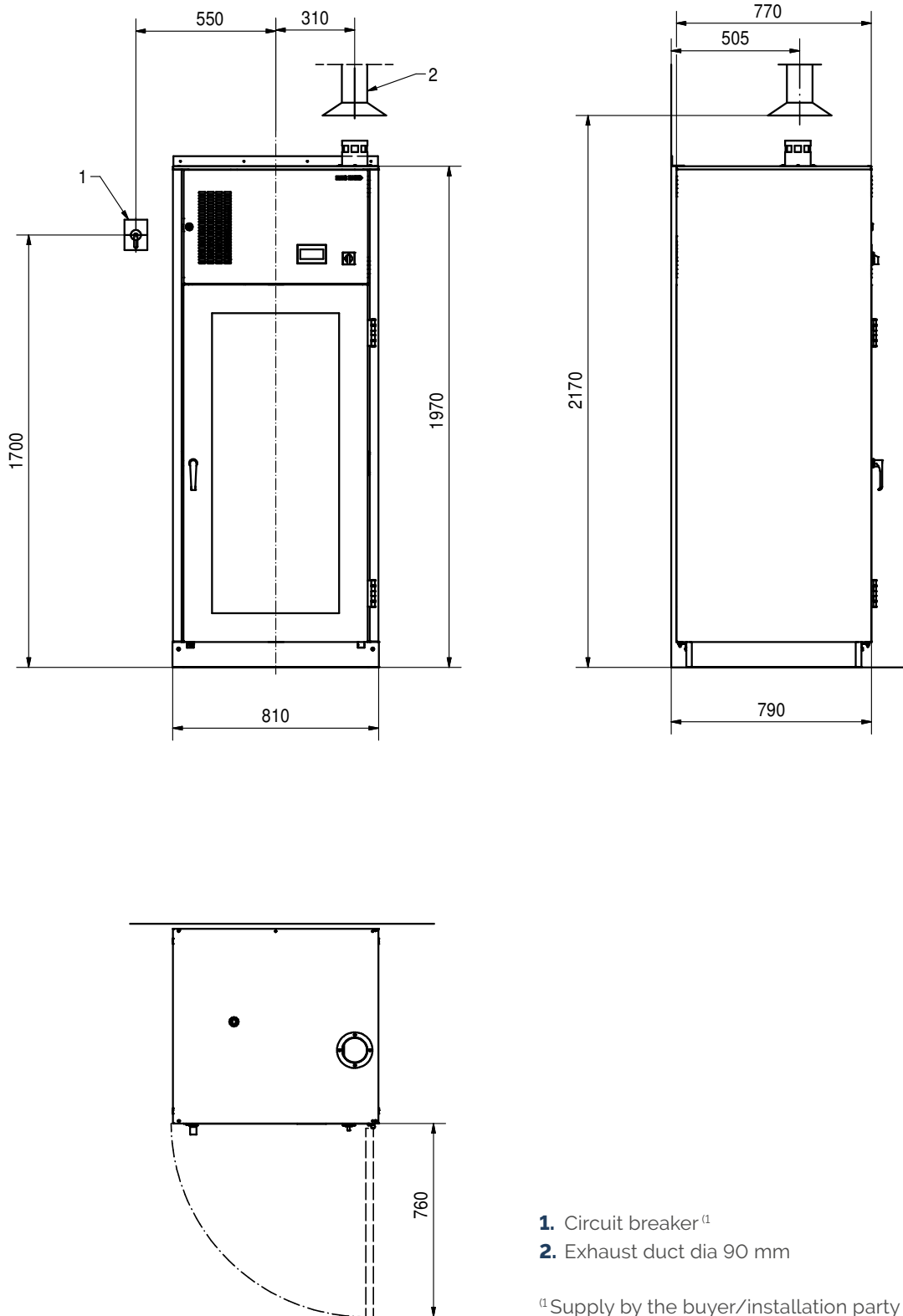

Double door (pass-through) model

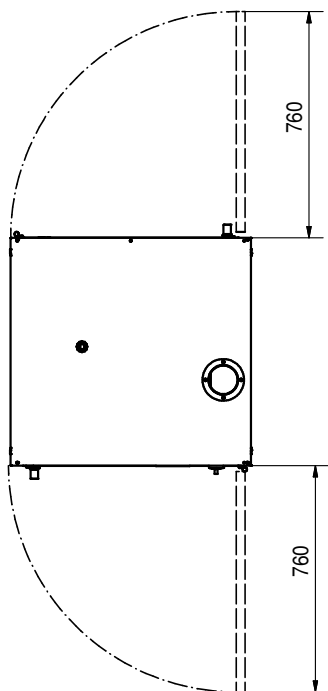
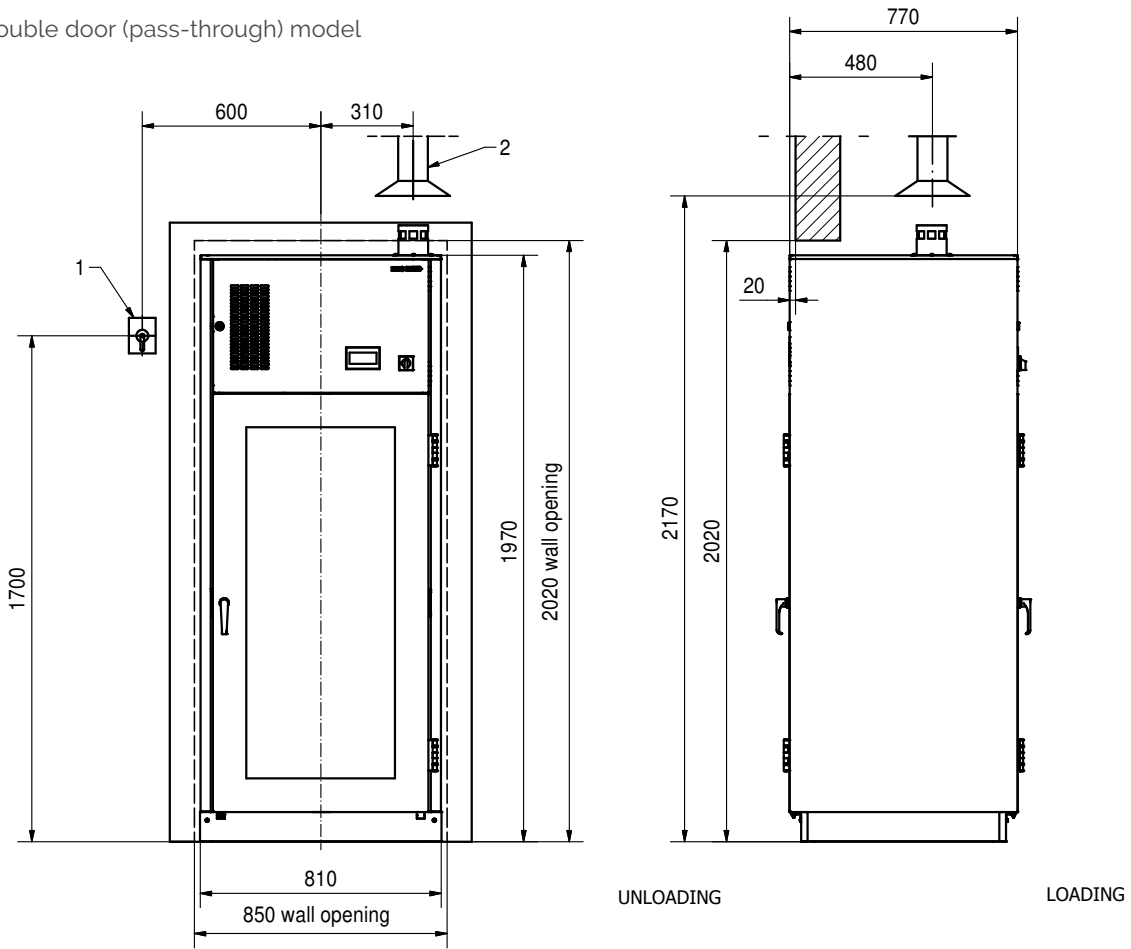

Wall opening width: 810 mm + 40 mm,
height: 2020 mm (single machine)

Door handing guide

Single door model:

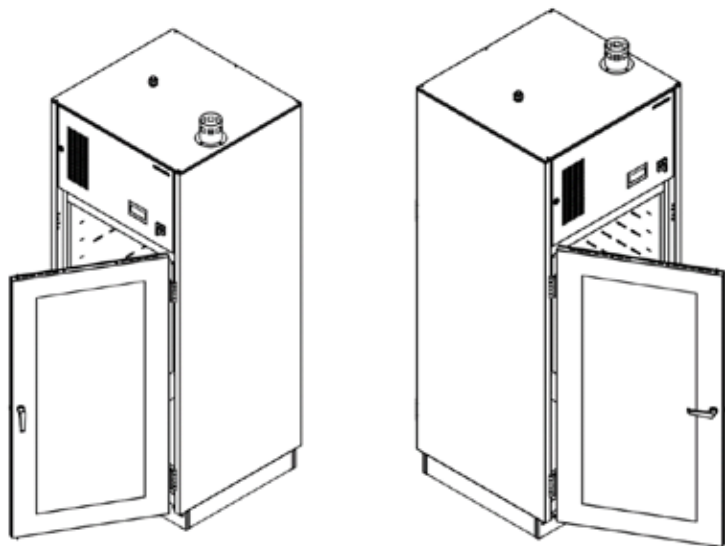

RH = Right-hand door

LH = Left-hand door

Double-door model:

RIGHT HAND DOOR

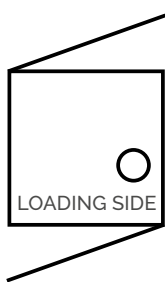

RIGHT HAND DOOR

LEFT HAND DOOR

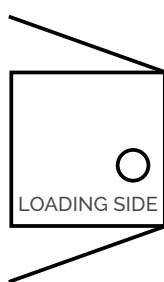

RIGHT HAND DOOR

LEFT HAND DOOR

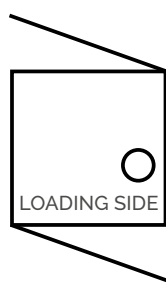

LEFT HAND DOOR

RIGHT HAND DOOR

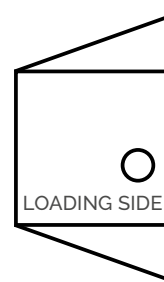

LEFT HAND DOOR

1. RH/RH = Right-hand door loading, right-hand door unloading

2. RH/LH = Right-hand door loading, left-hand door unloading

3. LH/LH = Left-hand door loading, left-hand door unloading

4. LH/RH = Left-hand door loading, right-hand door unloading

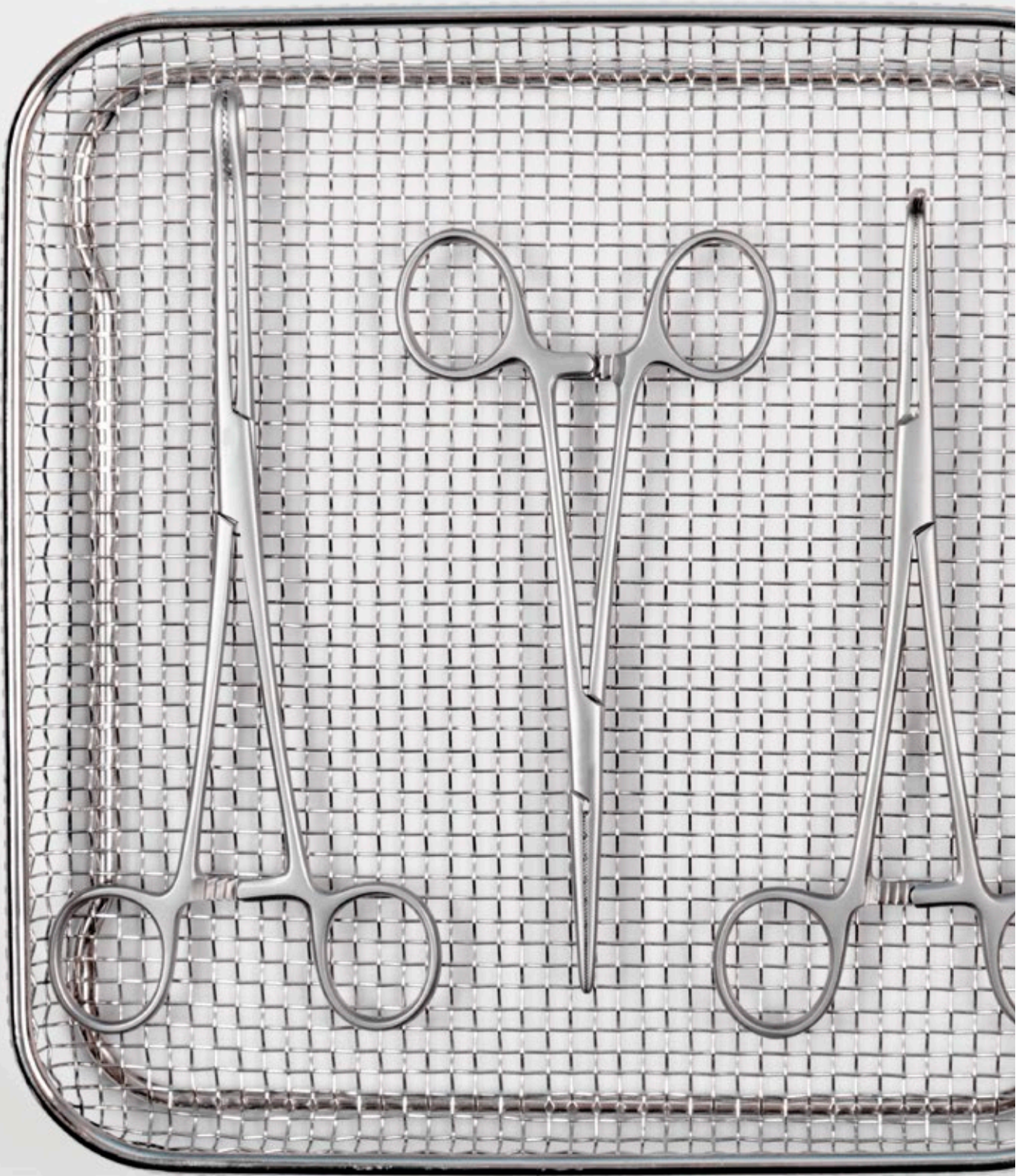



Preventing infections since 1976.

DEKO MedTech Oy | Vartiokuja 1 | FI-76850 Naarajärvi | Finland
www.dekomedtech.com

REV: 12/03/2025